

Fișă tehnică Canal, tip WDK 60060

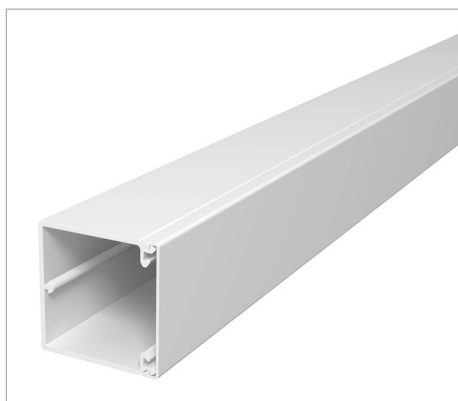

Capac și canal cu bază perforată.

Tip	Culoare	Lungime mm	Amb. m	Greutate kg/100 m	Nr. art.
WDK60060RW	alb pur; RAL 9010	2000	32	81.600	6191193
WDK60060CW	alb crem; RAL 9001	2000	32	81.600	6021948
WDK60060LGR	gri deschis; RAL 7035	2000	32	81.600	6027105
WDK60060GR	gri piatră; RAL 7030	2000	32	81.600	6025668

PVC Policlorură de vinil

€/m

