

Fișă tehnică Canal, tip WDK 40090

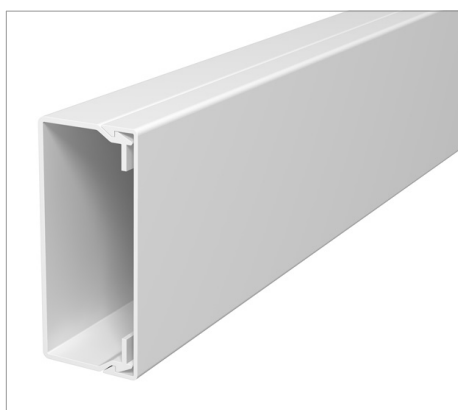

Capac și canal cu bază perforată.

Tip	Culoare	Lungime mm	Amb. m	Greutate kg/100 m	Nr. art.
WDK40090RW	alb pur; RAL 9010	2000	32	77.300	6191142
WDK40090CW	alb crem; RAL 9001	2000	32	77.300	6020895
WDK40090LGR	gri deschis; RAL 7035	2000	32	77.300	6027032
WDK40090GR	gri piatră; RAL 7030	2000	32	77.300	6021018

PVC Policlorură de vinil

€/m

