

Fișă tehnică Canal, tip WDK 60090

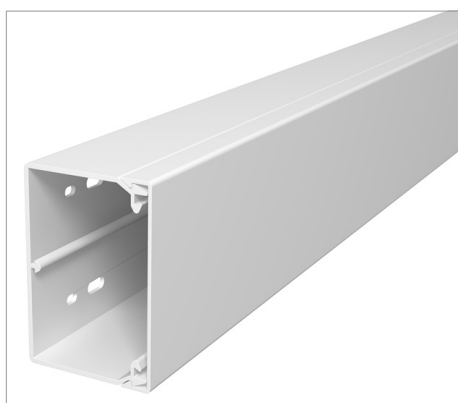

Capac și canal cu bază perforată.

Tip	Culoare	Lungime mm	Amb. m	Greutate kg/100 m	Nr. art.
WDK60090RW	alb pur; RAL 9010	2000	24	110.000	6191207
WDK60090CW	alb crem; RAL 9001	2000	24	110.000	6021913
WDK60090LGR	gri deschis; RAL 7035	2000	24	110.000	6027113
WDK60090GR	gri piatră; RAL 7030	2000	24	110.000	6022006

PVC Policlorură de vinil

€/m

